

## REVERSO SQUADRA

### REVERSO SQUADRA HOMETIME

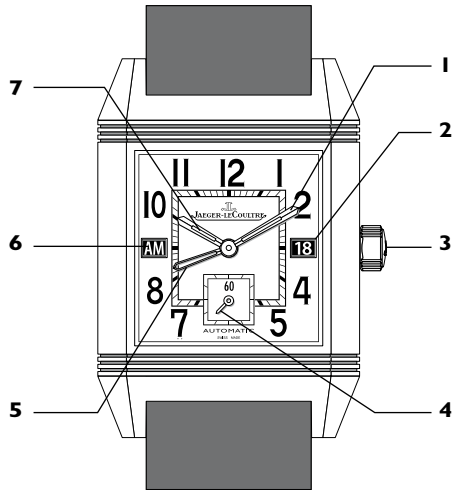

- 1 Minute hand
- 2 Date
- 3 Crown
- 4 Small seconds hand
- 5 Reference time hour hand (skeleton hand)
- 6 AM/PM indicator
- 7 Local time hour hand

### REVERSO SQUADRA CHRONOGRAPH GMT

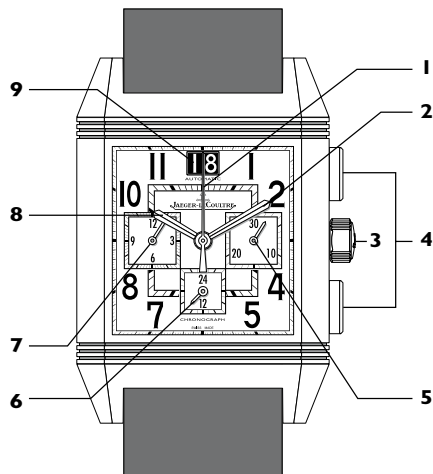

- 1 Chronograph seconds hand
- 2 Minute hand
- 3 Crown
- 4 Chronograph pushpieces
- 5 Minute counter
- 6 Second time-zone hand (24H GMT) in the counter located at 6 o'clock
- 7 Hour counter
- 8 Hour hand
- 9 Large date

### REVERSO SQUADRA WORLD CHRONOGRAPH

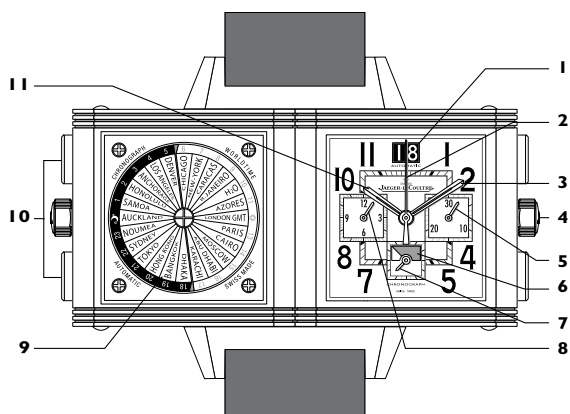

- 1 Large date
- 2 Chronograph seconds hand
- 3 Minute hand
- 4 Crown
- 5 Minute counter
- 6 Day/night indicator
- 7 Small seconds hand
- 8 Hour counter
- 9 World time (24-hour ring, rear side of the watch)
- 10 Chronograph pushpieces
- 11 Hour hand

## Introduction

We congratulate you on the purchase of your Jaeger-LeCoultre watch and thank you for your confidence.

Designed for men, the Reverso Squadra watch combines strength, elegance and robustness. An exceptionally forceful design, clear and useful functions. It sports the emblematic features of the legendary reversible watch in a square case.

We invite you to consult the operating instructions and we wish you great pleasure with your Jaeger-LeCoultre timepiece.

## Accuracy

### Mechanical models with manual or automatic winding

The precision of the mechanical models is determined by the balance. The latter performs 21,600 or 28,800 vibrations per hour depending on the model (see technical characteristics).

Despite all the care that the Jaeger-LeCoultre masterwatchmakers have lavished on making and assembling your watch, its accuracy is subject to the influence of gravity, magnetic fields, shocks, as well as ageing of the oils. This accuracy is measured by its rate regularity in various positions.

The nature of your temperament and of your daily activities may cause slight variations in timekeeping. If you were to notice that your watch is running slow or fast, we advise you to take it to an approved Jaeger-LeCoultre retailer, who will make any necessary adjustments.

### Quartz models

The quartz models are accurate to within 2 to 3 minutes per year.



Jaeger-LeCoultre quartz watches contain a battery and electronic components. When performing maintenance, your official Jaeger-LeCoultre Service Centre or your authorised Jaeger-LeCoultre retailer will take charge of their recovery and disposal in accordance with the standards in force.

## Water resistance

Jaeger-LeCoultre Reverso Squadra watches are water-resistant to 5 bar/atm. This property can be identified by the  symbol engraved on the case-back. This means that you can use your watch during short swims or when diving in from the edge, but not from a diving board. Nor should it be used for undersea diving or for sports where there are significant risks of hard knocks, such as windsurfing and waterskiing. Please also note that leather straps are not suitable for aquatic activities.

Furthermore, it is essential to have your watch's water-resistance checked by an authorised Jaeger-LeCoultre retailer at least once every two years, and definitely before any period in which it will undergo prolonged and/or regular immersion.

## The «1000 Hours Control» test by Jaeger-LeCoultre

Jaeger-LeCoultre subjects each of its watches to the rigorous «1000 Hours Control» test programme. Unique in its kind, this test consists of 1000 hours of comprehensive, stringent checks.

The «1000 Hours Control» seal or marking affixed or engraved on the back of your watch certifies that it has undergone this observation programme in our laboratories and has passed all the tests, relating to rate regularity, temperature and atmospheric pressure, resistance to impacts and magnetic fields, as well as water-resistance. Your watch is therefore capable of withstanding the trials awaiting it in everyday life when you wear it on your wrist.

The criteria of the «1000 Hours Control» programme go far beyond the official timekeeping test standards, which concern only part of the movement. Jaeger-LeCoultre tests not only the movement before casing it within the watch, but also the watch as a whole.

## Adjusting the bracelet

You can adjust your steel bracelet yourself. However, if you have a gold model, we advise you to entrust it to the nearest approved Jaeger-LeCoultre retailer, or to contact one of our official Service Centres listed at the end of the guarantee booklet.

### Adjusting the steel bracelet

Place the watch on your wrist. You can thus see how many links need to be added or removed.

Remove your watch by simultaneously pressing the pushpieces on either side of the clasp.

Hold the bracelet near the clasp. Using the adjustment tool, press the end of the bar (fig. 1) and lift up the link (fig. 2). Avoid the 2 links on either side of the clasp.

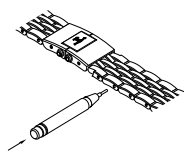

Fig. 1

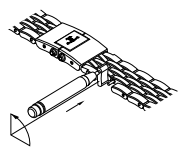

Fig. 2

Proceed in the same way for the following link (fig. 3) if you want to remove a single row of links (or the 2<sup>nd</sup>, 3<sup>rd</sup>, etc. if you want to remove 2, 3... rows of links).

Take out the two bars (fig. 4).

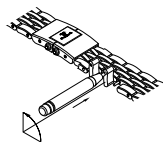

Fig. 3

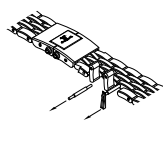

Fig. 4

Remove the row(s) of links (fig. 5).

Place the 2 ends of the bracelet back together and insert a bar (fig. 6).

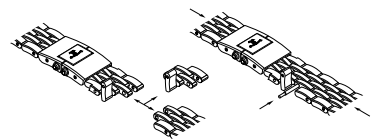

Fig. 5

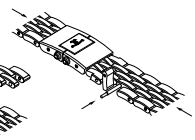

Fig. 6

Tip over the link, press on the end of the bar pivot and push your link down until it clicks (fig. 7).

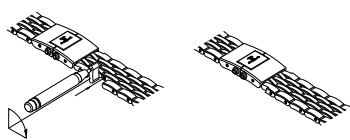

Fig. 7

## Adjusting the clasp

The clasp of your watch is fitted with a length-change system enabling you to lengthen or shorten your bracelet by 4 mm on each side, for enhanced wearer comfort.

### Using the fine adjustment system

Transition from the long position to the short position:

Remove your watch.

Hold your clasp open between the thumb and forefinger of one hand, with the bracelet section in your other hand (fig. 1).

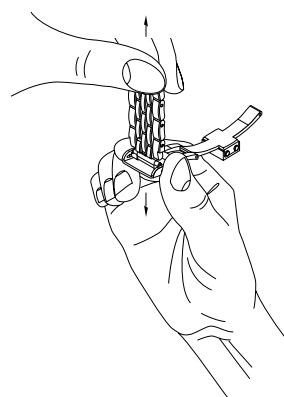
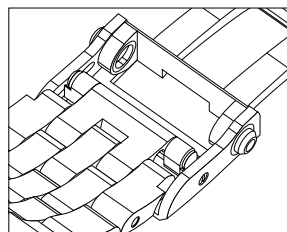
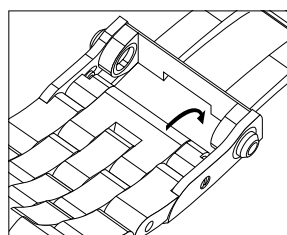

Fig. 1



Lift up the clasp cover so as to release the tip-over part of the bracelet section from its groove (fig. 2).

Fig. 2 Long position



Push the tip-over part of your bracelet section and place it in its groove, facing the opposite way to its initial position (fig. 3).

Fig. 3 Shortened position

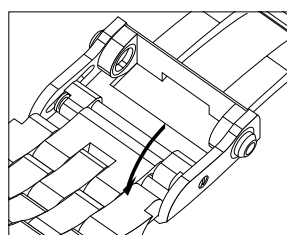

The transition from the short to the long position is done in the same manner, but in the opposite direction (fig. 4).

Fig. 4 Extended position

## REVERSO SQUADRA HOMETIME

### Technical characteristics

- Automatic winding mechanical movement, Calibre 977.
- 28,800 vibrations/hour.
- Power reserve : approximately 48 hours.

### Movement



Jaeger-LeCoultre Calibre 977.

### Functions

The Reverso Squadra Hometime watch model features a double set of hands allowing the local time on the main display to be changed rapidly by moving the corresponding hand forward or backward in 1-hour jumps, while maintaining a reference time thanks to an additional hour hand.

It offers the following functions :

- Local time adjusted rapidly and independently in both directions (time zone of the local city).
- Date synchronised with local time; can be changed in both directions.
- Reference time.
- AM/PM indication linked to the reference time.

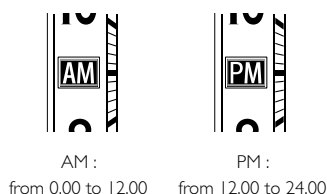

You may use the local time and reference time displays as you wish, for example :

- To indicate the same time in the local time display and reference time display; the two hands are placed one over the other and the watch offers a classic display.
- To set a different time on the main display while keeping the reference time indication on the additional hand (skeleton hand).

- To set the time for another time zone on the reference time display, so as to keep permanent track of the time there, with day/night indication (AM/PM).
- To indicate the official GMT time on the reference time display, so as to deduce any time zone according to its difference with the reference GMT time zone, and then display it on the local set of hands.

Whichever option you choose, the local time function enables you to set the time on the main display rapidly by 1-hour jumps in either direction, automatically driving the date.

This mechanism thus allows a different time to be set in a few operations, without losing the accuracy of the minute and seconds hands.

### Use

The crown of the Reverso Squadra Hometime watch allows you to :

- Wind the watch if it has not been worn for over 48 hours (crown in position 1).
- Set the local hour/minutes (time zone of the local city) and the date (crown in position 2).
- Set the reference time, driving the AM/PM indication (crown in position 3).

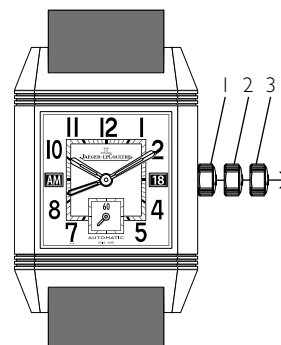

### Starting the watch

Crown in position 1.

A few clockwise turns of the crown are enough to set the watch running. It is then automatically wound when you wear it. Please note that the crown does not lock on winding, even when the watch is fully wound.

### Adjusting the reference time

This is the first setting to be performed because it allows you to determine the reference time and its AM/PM indication and set the watch in minutes and seconds precisely, and it automatically drives the other functions, namely the minutes, local time, date and AM/PM indication.

Pull the crown out to position 3.

The movement is then locked («stop seconds» function). To enable precise time setting to within one second, stop the seconds hand in a vertical position so as to indicate 60 seconds.

Move the reference time hand and the minute hand forward or backward until the desired time is displayed, while taking into account the AM/PM indication.

#### Note

During this operation, the local time hand (like the date) is driven automatically; the difference relative to the reference time is therefore maintained.

Once the correct time has been set, push the crown back to position 1. The watch then starts operating again.

#### Adjusting the local time (main display)

Pull the crown out to position 2.

You may turn the crown in both directions; the main hour hand and the date are driven either forward or backward depending on the chosen direction. The hour hand moves in 1-hour jumps. Please note that the date is corrected by one day whenever the local time hour hand has moved twice around the dial. The minute hand and the small seconds hand are not affected by this operation and keep running, thus preserving the precise setting of the watch.

#### Date setting (semi-fast setting)

Before setting the local time, the date should be set as follows. Turn the crown forward or backward (depending on the closest distance between the date indicated and the desired date), and turn the hour hand as many times as required until the desired date is displayed.

#### Local time setting

After adjusting the date, move the local time forward or backward to bring it to the desired time, while moving past midnight in order to take account of the date indication :

- You have turned the crown clockwise : if the date moves forward when moving past midnight, you are moving into the morning zone.
- You have turned the crown counter-clockwise : if the date moves backwards when moving past midnight, you are moving back into the evening zone.

When the operation is completed, push the crown back to position 1.

## REVERSO SQUADRA CHRONOGRAPH GMT

### Technical characteristics

- Automatic winding mechanical movement, Calibre 754.
- 28,800 vibrations/hour.
- Power reserve : approximately 65 hours.

### Movement

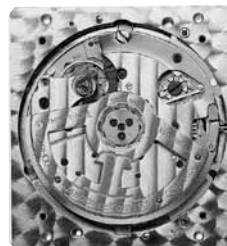

Jaeger-LeCoultre Calibre 754.

### Functions and displays

- Chronograph.
- Second time zone (time indication over 24 hours).
- Large date.
- Hour, minute.

### Use

#### Starting the watch

Crown in position 1.

A few clockwise turns of the crown are enough to set the watch running. It is then automatically wound when you wear it. Please note that the crown does not lock on winding, even when the watch is fully wound.

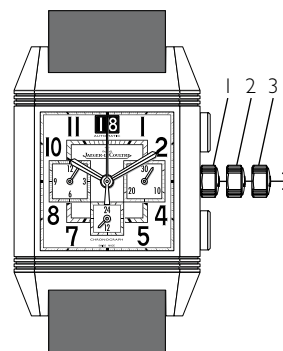

### Setting the hour and minutes

Pull the crown out to position 3.

Move the hands clockwise up to the desired time and push the crown back to position 1. The watch then starts operating again.

### Setting the large date display

Pull the crown out to position 2.

Move the date forward by turning the crown counter-clockwise. Perform the required number of turns until the desired date is displayed.

**Note : date correction should not be performed between 10.30 pm and 3.30 am. During that period the automatic date-change mechanism is already in action.**

When the operation is completed, push the crown back to position 1.

### Setting the second time zone

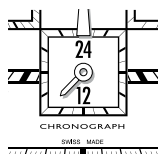

Pull the crown out to position 2.

Move the second time-zone hand forward by turning the crown clockwise until the desired time is displayed in the counter located at 6 o'clock, taking into account the fact that this is a 24-hour display.

When the operation is completed, push the crown back to position 1.

### Chronograph operation

The central seconds hand on the Reverso Squadra Chronograph GMT displays the chronograph seconds with an eighth-of-a-second definition. A counter located at 3 o'clock totals the minutes up to 30 minutes (after one turn, it counts another 30 minutes). Another counter located at 9 o'clock totals the hours up to 12 hours (after one turn, it counts another 12 hours).

- Pushpiece at 2 o'clock : this pushpiece enables the chronograph function to be started and stopped. By pressing once on the pushpiece at 2 o'clock, the chronograph is activated. The central seconds hand turns and the minute and hour totaliser counters are in operation. A second press on the pushpiece at 2 o'clock stops the chronograph and enables the time elapsed to be read off.
- Pushpiece at 4 o'clock : this pushpiece allows you to reset the counters and the central seconds hand. When timing is in progress, a press on this pushpiece has no effect.

#### Note

It is possible to obtain the total of several timing operations by pressing again on the pushpiece at 2 o'clock (without resetting the counters). Timing starts again and the time is added to the previous measurement.

## REVERSO SQUADRA WORLD CHRONOGRAPH

### Technical characteristics

- Automatic winding movement, Calibre 753.
- 28,800 vibrations/hour.
- Power reserve : approximately 65 hours.

### Movement



Jaeger-LeCoultre Calibre 753.

### Functions and displays

- Chronograph.
- World Time, with instant reading of the time in the 24 time zones of the world.
- Large date.
- Hour, minute, small seconds.
- Day/night indicator.

### Use

#### Starting the watch

Crown in position 1.

A few clockwise turns of the crown are enough to set the watch running. It is then automatically wound when you wear it. Please note that the crown does not lock on winding, even when the watch is fully wound.

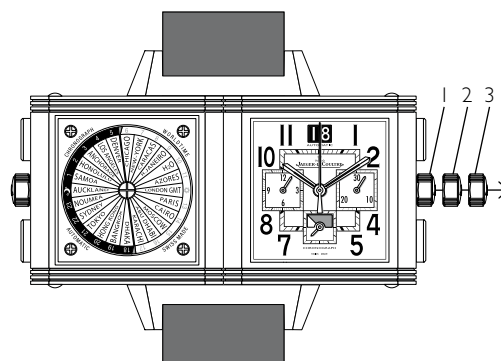

### Setting the local time (reference time)

Pull the crown out to position 3.

The movement is then locked («stop seconds» function). To enable precise time setting to within one second, stop the second hand in a vertical position so as to indicate 60 seconds.

Move the hands clockwise to the desired time, taking into account the day/night indication.

Once the correct time has been set, push the crown back to position 1. The watch then starts operating again.

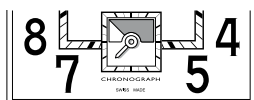

Night : red, 6 pm - 6 am  
Day : white, 6 am - 6 pm

### Setting the large date display

Pull the crown out to position 2.

Move the date forward by turning the crown counter-clockwise. Perform the required number of turns, until the desired date is displayed.

**Note : date correction should not be performed between 10.30 pm and 3.30 am. During that period the automatic date-change mechanism is already in action.**

When the operation is completed, push the crown back to position 1.

### World Time operation

Your Reverso Squadra World Chronograph watch has an ingenious world time display system enabling it to indicate the time in 24 cities of the world simultaneously.

Instant reading of the time in the 24 time zones of the world is thus possible thanks to the combination of the fixed city disc in the centre of the dial and the 24-hour rotating ring.

#### Initial setting of the world time display system

- Front side of the watch, crown in position 3 :  
Set the local hour and minutes according to the instructions above (setting the reference time).
- Rear side, crown in position 2 :  
On the fixed city disc in the centre of the dial, locate the city corresponding to your geographic location (time zone of your reference city, i.e. the time set on the front side of your watch during the previous operation). Then turn the crown clockwise so as to bring the local time indicated on the 24-hour ring opposite the reference city. Following these operations, the times shown on the front and rear of your watch will be identical.

Once this setting has been performed :

- The 24-hour ring moves with the local time (reference time shown on the front side of your watch), and moves round the dial once in 24 hours. It updates the time for each of the cities according to the local time.
- You can thus at any moment read the time in any city indicated on the fixed city disc in the centre of the dial, by combining the hour opposite the city in question with the minutes located on the front of your watch.

This setting is performed just once, so long as the main time zone (the reference time zone) remains the same. However, this setting operation will need to be done again if, during a trip, you wish to adopt the new time as reference time.

In this case, please repeat the system setting procedure as indicated above, adopting this new time as reference time. You will thus be able to again read the time in any city on the basis of your new reference city.

#### Note

The few regions in which the official time differs by a fraction of an hour (India, Iran, Nepal) do not appear on the city disc.

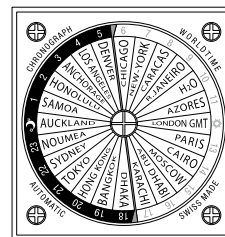

6 pm - 6 am : Night  
6 am - 6 pm : Day

24 cities, identification of the 24 time zones

### Chronograph operation

The central seconds hand on the Reverso Squadra World Chronograph displays the chronograph seconds with an eighth-of-a-second definition. A counter located at 3 o'clock totals the minutes up to 30 minutes (after one turn, it counts another 30 minutes). Another counter located at 9 o'clock totals the hours up to 12 hours (after one turn, it counts another 12 hours).

- Pushpiece at 2 o'clock : this pushpiece enables the chronograph function to be started and stopped. By pressing once on the pushpiece at 2 o'clock, the chronograph is activated. The central seconds hand turns and the minute and hour totaliser counters are in operation. A second press on the pushpiece at 2 o'clock stops the chronograph and enables the time elapsed to be read off.
- Pushpiece at 4 o'clock : this pushpiece allows you to reset the counters and the central seconds hand. When timing is in progress, a press on this pushpiece has no effect.

#### Note

It is possible to obtain the total of several timing operations by pressing again on the pushpiece at 2 o'clock (without resetting the counters). Timing starts again and the time is added to the previous measurement.

## International Guarantee

**This International Guarantee applies to Jaeger-LeCoultre products sold or presented for guarantee repairs in all countries except the United States of America and Canada (for those two countries, see the Limited Warranty).**

The manufacturer's International Guarantee applies only to Jaeger-LeCoultre products purchased from authorised Jaeger-LeCoultre retailers. In addition, all maintenance and repair works must be carried out either by an authorised Jaeger-LeCoultre retailer or by an official Jaeger-LeCoultre Service Centre. If these conditions are not met, the manufacturer's guarantee does not apply. For a list of authorised Jaeger-LeCoultre retailers worldwide, please contact Jaeger-LeCoultre or its Distributors.

### Jaeger-LeCoultre watches

The terms and conditions of the Jaeger-LeCoultre International Guarantee

The following terms and conditions of the Jaeger-LeCoultre International Guarantee apply to watches sold or presented for guarantee repairs in all countries except the United States of America and Canada (for those two countries, see the Limited Warranty).

Your Jaeger-LeCoultre watch is guaranteed against all manufacturing defects for two years from the date of purchase, subject to the following conditions.

Any part found by our technical services to be defective as a result of a manufacturing defect will be, at the sole discretion of Jaeger-LeCoultre, repaired or replaced free of charge.

The Jaeger-LeCoultre International Guarantee is valid only if the guarantee certificate enclosed with this booklet has been duly completed, dated, stamped and signed by the authorised Jaeger-LeCoultre retailer who sold your watch.

This International Guarantee does not cover defects resulting from accidents, mishandling or incorrect or abusive use (for example, knocks, dents, crushing, excessive temperatures, powerful magnetic fields), the use of or effect of using batteries other than those designated by Jaeger-LeCoultre, unauthorised alteration or repair or the consequences of normal wear and ageing of the watch, the strap or the glass, the loss of water resistance after two years after the date of purchase if your watch is water-resistant, and any defect resulting from the contact with water if your watch is not water-resistant.

Jaeger-LeCoultre water-resistant watches may be identified by the symbol  engraved on the back. Their water resistance is guaranteed for two years from the date of purchase, provided that the glass, the bezel, the back, the middle part and the crown have not been damaged. It is essential to have the water resistance checked by an authorised Jaeger-LeCoultre retailer or an official Jaeger-LeCoultre Service Centre at least once a year; and in any event, prior to any period of intensive use. Please refer to the operating instructions for further details.

For quartz watches, this guarantee does not cover the battery life.

**As a consumer, you may have legal rights under applicable national legislation governing the sale of consumer goods; those rights are not affected by this guarantee.**

### Customer service at Jaeger-LeCoultre

The movement of a mechanical watch requires regular maintenance (servicing, lubrication, etc.) to ensure a long operating life. Should your watch need servicing or repairs, please send it, together with its guarantee certificate, to the authorised Jaeger-LeCoultre retailer who sold it to you.

Alternatively, you may send it to one of the official Jaeger-LeCoultre Service Centres listed at the end of this booklet, or to any authorised Jaeger-LeCoultre retailer of which a list is available on the «[www.jaeger-lecoultre.com](http://www.jaeger-lecoultre.com)» website.

Our official Service Centres employ watchmakers trained at the Jaeger-LeCoultre Manufacture and possess the tools and parts necessary to repair and maintain all Jaeger-LeCoultre watches and clocks. In certain cases, especially for operations requiring special tools and parts, the Service Centres will send your watch to the Jaeger-LeCoultre Manufacture in Switzerland to have the necessary work carried out.

In any case, or if you live in a country which is not indicated in our lists, please do not hesitate to contact directly Manufacture Jaeger-LeCoultre in Switzerland, Rue de la Golisse 8, 1347 Le Sentier; telephone +41 21 845 02 02, fax +41 21 845 05 50, which will inform you of the procedure to follow. We also invite you to visit our website «[www.jaeger-lecoultre.com](http://www.jaeger-lecoultre.com)» for an updated list of official Jaeger-LeCoultre Service Centres.

## Limited Warranty

The following Limited Warranty applies to Jaeger-LeCoultre products sold or presented for warranty repairs in the United States of America and Canada only.

The manufacturer's Limited Warranty applies only to Jaeger-LeCoultre products purchased from authorised Jaeger-LeCoultre retailers. In addition, all maintenance and repair works must be carried out either by an authorised Jaeger-LeCoultre retailer or by an official Jaeger-LeCoultre Service Centre. If these conditions are not met, the manufacturer's Limited Warranty does not apply. For a list of authorised Jaeger-LeCoultre retailers worldwide, please contact Jaeger-LeCoultre or its Distributors.

### Jaeger-LeCoultre watches

The terms and conditions of the Jaeger-LeCoultre Limited Warranty

The following terms and conditions of the Jaeger-LeCoultre Limited Warranty apply only to watches sold or presented for warranty repairs in the United States of America and Canada.

Your Jaeger-LeCoultre watch is guaranteed against all manufacturing defects for two years from the date of purchase, subject to the following conditions.

Any part found by our technical services to be defective as a result of a manufacturing defect will be, at the sole discretion of Jaeger-LeCoultre, repaired or replaced free of charge.

The Jaeger-LeCoultre Limited Warranty is valid only if the warranty certificate enclosed with this booklet has been duly completed, dated, stamped and signed by the authorised Jaeger-LeCoultre retailer who sold your watch.

This Limited Warranty does not cover defects resulting from accidents, mishandling or incorrect or abusive use (for example, knocks, dents, crushing, excessive temperatures, powerful magnetic fields), the use of or effect of using batteries other than those designated by Jaeger-LeCoultre, unauthorised alteration or repair or the consequences of normal wear and ageing of the watch, the strap or the glass, the loss of water resistance after two years after the date of purchase if your watch is water-resistant, and any defect resulting from the contact with water if your watch is not water-resistant.

Jaeger-LeCoultre water-resistant watches may be identified by the symbol  engraved on the back. Their resistance is guaranteed for two years from the date of purchase, provided that the glass, the bezel, the back, the middle part and the crown have not been damaged. It is essential to have the water resistance checked by an authorised Jaeger-LeCoultre retailer or an official Jaeger-LeCoultre Service Centre at least once a year, and in any event, prior to any period of intensive use. (Please refer to the operating instructions for further details).

For quartz watches, this warranty does not cover the battery life.

Except insofar as prohibited by applicable law, this Limited Warranty shall be the exclusive manufacturer's warranty.

Neither this Limited Warranty nor any other warranties, whether express or implied, including, but not limited to, any implied warranty of merchantability or of fitness for any particular purpose, shall extend beyond the period of two years from the date of purchase.

The liability of Jaeger-LeCoultre is limited solely and exclusively to repair or replacement under the terms and conditions stated herein. Jaeger-LeCoultre shall not be liable, by virtue of this Limited Warranty or otherwise, for any loss or damage arising out of the use of or inability to use this watch nor for any incidental or consequential damages relating in any way to this watch. Some States, Provinces and Territories do not allow limitations on how long an implied warranty lasts or the exclusion or limitation of incidental or consequential damages, so the above limitations or exclusions may not apply to you.

This Limited Warranty grants you specific legal rights, in addition to which you may have other legal rights which vary from one Country, State, Province or Territory to another.

### Customer service at Jaeger-LeCoultre

The movement of a mechanical watch requires regular maintenance (servicing, lubrication, etc.) to ensure a long operating life. Should your watch need servicing or repairs, please send it, together with its warranty certificate, to the authorised Jaeger-LeCoultre retailer who sold it to you.

Alternatively, you may send it to one of the official Jaeger-LeCoultre Service Centres listed at the end of this booklet, or to any authorised Jaeger-LeCoultre retailer of which a list is available on the «[www.jaeger-lecoultre.com](http://www.jaeger-lecoultre.com)» website.

Our official Service Centres employ watchmakers trained at the Jaeger-LeCoultre Manufacture and possess the tools and parts necessary to repair and maintain all Jaeger-LeCoultre watches and clocks.

In certain cases, especially for operations requiring special tools and parts, the Service Centres will send your watch to the Jaeger-LeCoultre Manufacture in Switzerland to have the necessary work carried out.

In any case, or if you live in a country which is not indicated in our lists, please do not hesitate to contact directly Manufacture Jaeger-LeCoultre in Switzerland, Rue de la Golisse 8, 1347 Le Sentier, telephone +41 21 845 02 02, fax +41 21 845 05 50, which will inform you of the procedure to follow. We also invite you to visit our website «[www.jaeger-lecoultre.com](http://www.jaeger-lecoultre.com)» for an updated list of official Jaeger-LeCoultre Service Centres.